

# Charlton & Jenrick<sup>LTD</sup>

*Best of British fires, fireplaces & stoves*

## **Inset LED Electric Fire**

**Model No. K101**

### **INSTALLATION AND OPERATION INSTRUCTIONS**

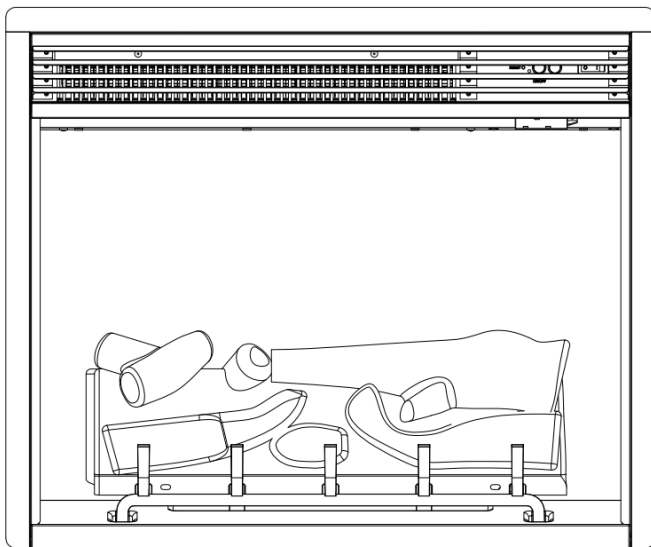

**Please read the instructions carefully before use and keep for future reference.**

# CONTENTS

1. Important Safety Information.....	1
2. Technical Specifications.....	3
3. Parts and Hardware.....	4
4. Appliance Dimensions.....	5
5. Installation Instructions.....	5
6. Operating Instructions.....	7
6a. Manual Controls.....	8
6b. Remote Controls.....	9
7. Maintenance.....	14
8. Others.....	15

## 1. IMPORTANT SAFETY INFORMATION

- 1.1 **Read these instructions carefully before using the appliance.**
- 1.2 **For indoor use only.** This appliance is not suitable for use outside the house and **only suitable for well insulated spaces or occasional use.**
- 1.3 The appliance must not be installed in a bath or shower room or where it or its controls can be contacted by persons with wet hand.
- 1.4 Do not use this fire as a free-standing appliance. It must always be fixed to the wall, fireplace mantel, floor etc.
- 1.5 This fire must not be located immediately below a socket-outlet.
- 1.6 This appliance must be earthed.
- 1.7 This appliance must not be supplied through an external switching device, such as a timer, or connected to the circuit that is regularly switched on and off by utility in order to avoid a hazard due to the inadvertent resetting of the thermal cut out.
- 1.8 If the power cord is damaged, it must be repaired by the manufacturer, its authorised service centre or professional person.
- 1.9 **Do not cover: Warning:** in order to avoid overheating, do not allow the appliance to be covered or let the air inlet/outlet become obstructed. Please note the warning symbol on the appliance (see above).

- 1.10 To reduce the risk of fire, keep textiles, curtains, or any other flammable material a minimum distance of 60cm from the air outlet.
- 1.11 Keep the power cord away from hot surfaces and hot conditions. Do not route the power lead in front of the appliance.
- 1.12 Do not use this fire in rooms that have explosive gas in them (for example petrol), or if you are using solvents, glue, aerosol spray or in flammable paints, as these may catch fire.
- 1.13 For young children and vulnerable persons care should be taken to avoid possible contact with the hot working areas of this appliance, fitting a suitable fireguard would meet this requirement.
- 1.14 Do not use this appliance in small rooms when they are occupied by persons not capable of leaving the room on their own, unless constant supervision is provided.
- 1.15 For young children and vulnerable persons care should be taken to avoid possible contact with the hot working areas of this appliance, fitting a suitable fireguard would meet this requirement.
- 1.16 This appliance can be used by responsible adults only.
- 1.17 Cleaning and user maintenance should only be carried out by responsible adults.
- 1.18 Children should not play with the appliance.

1.19 Children of less than 3 years should be kept away unless continuously supervised.

1.20 Keep the power plug accessible after installation.

**Information below for authorized person or service centre only:**

A non-rewireable plug fitted with a 13A fuse is supplied. Should the fuse or plug need replacing, and you are competent to do so, it must be replaced with a 13A fuse or plug being 13A BS1363A approved.

## 2. TECHNICAL SPECIFICATIONS

Model No.: K101

Supply Voltage: AC 220-240V 50Hz

Maximum power consumption: 1800-2000W

Power for flame effect: 6.5W (LED 2.5W + Motor for flame 4W)

### Heat Output:

Nominal heat output (Pnom): 2KW

Minimum heat output(indicative) (Pmin): 1KW

Maximum continuous heat output (Pmax): 2KW

### Auxiliary Electricity Consumption:

At nominal heat output (elmax): 12.5W

At minimum heat output (elmin): 12W

In standby mode (elSB): 0.49W

### Type of heat output / room temperature control





Single stage heat output and no room temperature control	No
Two or more manual stages, no room temperature control	No
With mechanic thermostat room temperature control	No
With electronic room temperature control	Yes
Electronic room temperature control plus day timer	Yes
Electronic room temperature control plus week timer	Yes

## Other Control Options

Room temperature control, with presence detection	No
Room temperature control, with open window detection	Yes
With distance control option	No
With adaptive start control	Yes
With working time limitation	No
With black bulb sensor	No

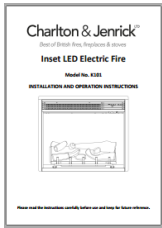
## 3. PARTS AND HARDWARE

- 3.1 Unpack the fire carefully, make sure that the appliance is intact with no signs of damage caused by transport and no part has been exposed to water. If in doubt, do not use the appliance and contact an authorised service centre.
- 3.2 Keep plastic wrapping away from children.
- 3.3 Save the original packaging as this may be required in the event of service complaint with product.
- 3.4 Check that all parts are removed from the packing.

<p>A</p> 	<p>B</p> 	<p>C</p> 
<p>Manual Instruction (1)</p>	<p>Remote (1)</p>	<p>AAA Battery (2)</p>
<p>D</p> 		
<p>ST4*16 screws (4)</p>		

## 4. APPLIANCE DIMENSION

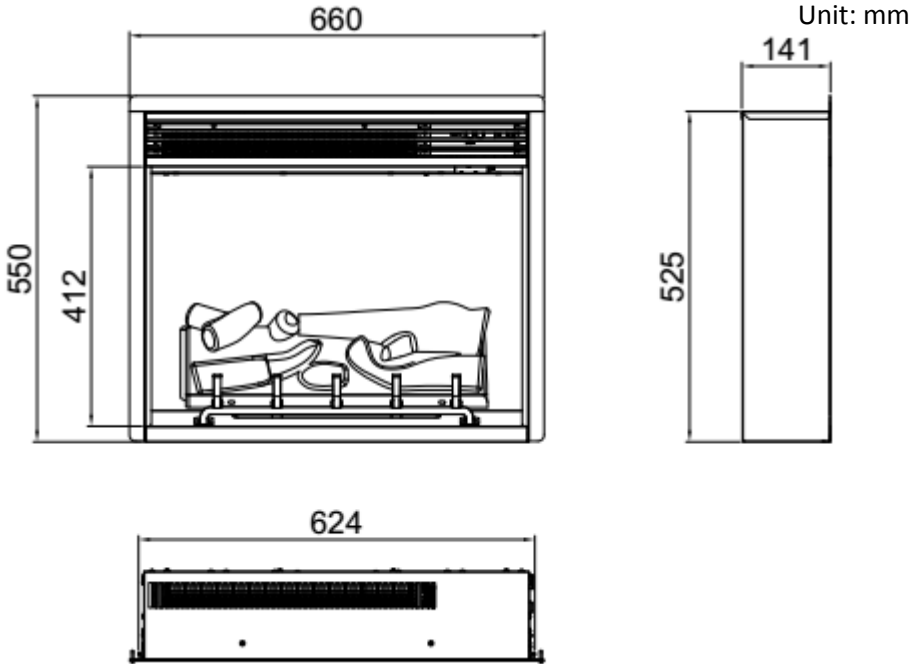

## 5. INSTALLATION INSTRUCTIONS

### Tools Required

A screw driver will be needed.

### Locating the Appliance

Your new electric fire will already be fixed into a purpose made suite which can be fixed back to the wall with the brackets provided. The 4 suite may be installed virtually anywhere in your home. However, when choosing a location, ensure that the general instructions are followed.

- 5.1 For best results, install out of direct sunlight.
- 5.2 The appliance should be connected to an earthed electrical outlet and it must be easily accessible to allow disconnection.
- 5.3 Position or secure the suite back against the wall ensuring that the electrical supply cable reaches the required socket outlet.

5.4 Put the fireplace engine into the suite from the front following the direction shown as below. Make sure the engine box is fully inserted and well positioned.

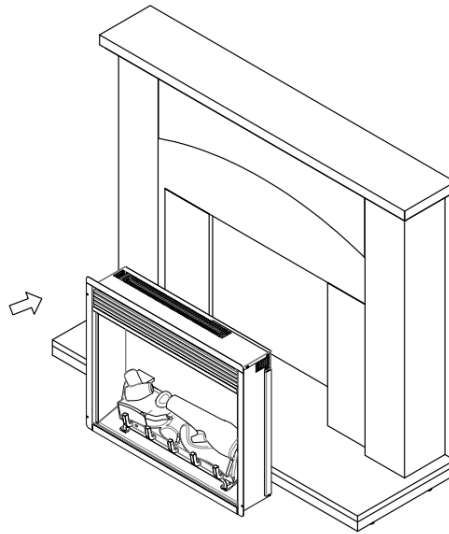

5.5 Fix the engine box with the suite with four ST4\*16 screws supplied.

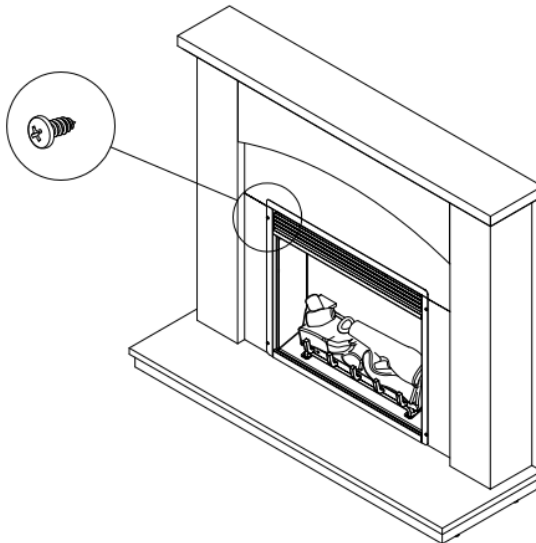

5.6 Place the 'trim' supplied separately from Charlton&Jenrick Ltd. if such arrangement is preferred.



5.7 The product is fitted with a non-rewireable plug with a 13Amp fuse. Only competent persons should attempt replacement.

## 6. OPERATING INSTRUCTIONS

**WARNING!** Do not operate this appliance if it has damage or malfunctions in anyway. If you suspect the appliance is damaged or malfunctions call a qualified service engineer to inspect the appliance, and carryout any necessary repair.

**WARNING!** To reduce the risk of fire, keep textiles, curtains, or any other flammable material a minimum distance of 1 meter from the air outlet.

**MAKE SURE** the plug fits tight in the outlet. Faulty wall outlet connections or loose plugs can cause the outlet to overheat.

**Do not** disconnect the power at the mains supply whilst the appliance is running. Use the functions on the remote to turn the fire off and ensure the mains switch has been moved to the off position before disconnecting.

### PREPARING TO USE

**NOTE:** To use the side switch control the mains on/off switch must be in 'ON' position. To prevent the product becoming too hot, there is 10s delay when turning on the heater and a 10s delay when turning off the heater fan.

### Main Power Switch

- 6.1 The mains power switch is located on the right- hand side of the heater box on the front of the appliance.
- 6.2 Switch ON (—) before operating the remote control.
- 6.3 A long beep is heard to indicate the fire is ready for use.

## 6a. MANUAL CONTROL PANEL

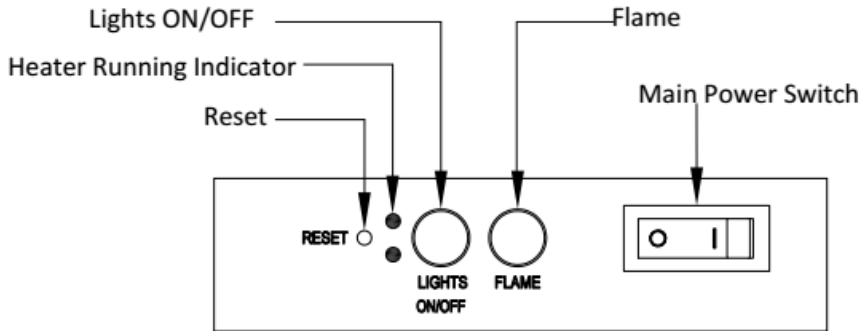

**NOTE: The manual button controls basic functions, not a full range of controls. Use the remote hand set to carry out all functions.**

6a.1 The manual buttons are located at the upper front of the appliance.

6a.2 Press "LIGHTS ON/OFF" to turn on or turn off both the flame effect.

6a.3 Press "FLAME" button to select the colour of flame (3 kinds) or return to the OFF position.

**NOTE: The controls on appliance will lose the memory for all function settings when the switch is set to the Off Position.**

When the remote runs out of power or when you change the batteries, only the flame function will lose memory and will not affect the timer settings, however, the clock may need adjusting.

## 6b. REMOTE CONTROLS

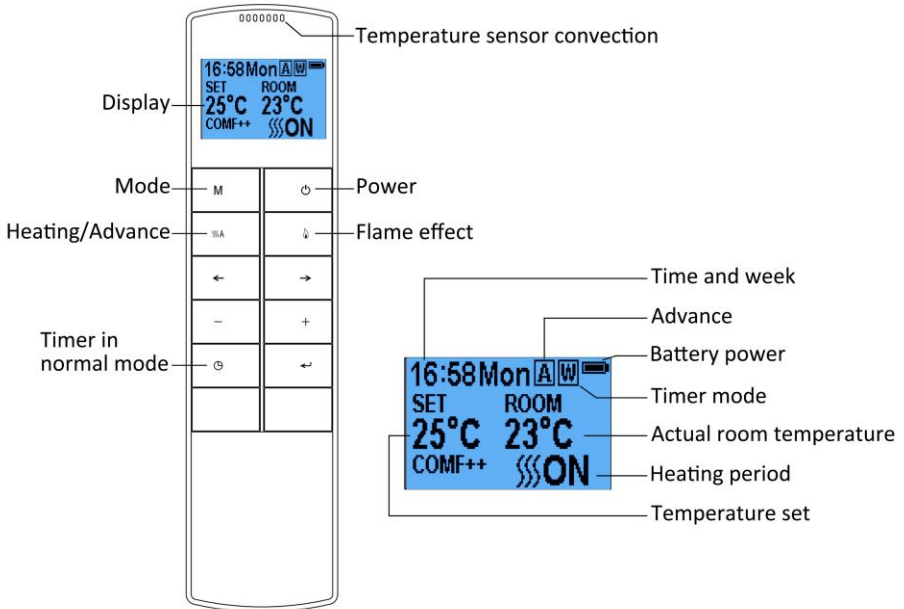

**NOTE: This is thermostatic remote control. The remote should be in the same room as fireplace and placed on a flat surface. It must be placed away from the fire so the hot air will not blow on it and affect thermostatic reading.**

### Standby for remote control

6a.1 The screen shown to the right is when the remote is in standby mode.



Before Day/Time set up

### Turn on/off

6a.2 Press  to turn on the flame effect, turn off flame effect and heater when in normal mode.



After Day/Time set up



6a.3 Press  to turn on/off the flame effect under daily and weekly timer mode.

## Flame Effect

- 6a.4 Press  to enter the flame effect adjustment screen.
- 6a.5 Press the '←' and '→' button to select the 3 Kinds of flame effect.
- 6a.6 Press the '+' and '-' button to select the 5 brightness of flame effect and OFF settings.



## Normal Mode

- 6a.7 Normal control mode is factory set. If it is not, then press **M** button until the logo **N** shows up at the upper right corner of the screen.
- 6a.8 Press the '+' and '-' button to adjust the setting temperature from 17°C to 25°C by 2 intervals.
- 6a.9 Press  **A** button to turn on/off heat,  ON,  OFF will show at the lower of the screen.

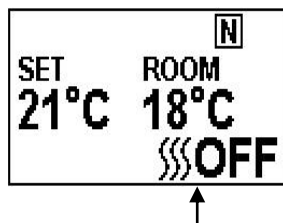
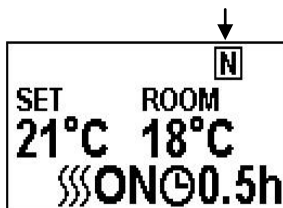

**NOTE:** It is normal for the fan heater to stop running for periods of time. This happens because the room temperature is at or above the temperature set on the remote control. The heater indicator will be turned off after 10s if you have the flame ON. The heater indicator will stay ON if you use the heating function only.

## Count Down Timer

**NOTE:** This setting is only for normal mode. It allows the appliance to go into standby after a set period of time.

- 6a.10 Press  to cycle through the settings from Off and 0.5 hours to 9 hours. The timer logo and time will show on the screen.

**The heater must be in ON position.**

The heater can be automatically run by using daily timer and weekly timer on the side switch.

### Set up Day, Time, Comfortable temperature.

6a.11 Press  to turn on the remote. Hold the button **M** for 3 seconds to enter the setting screen.

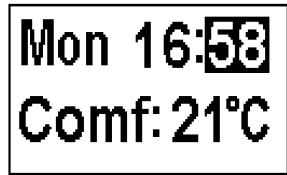

6a.12 Press the '←' and '→' button to choose Day, Time or your comfortable temperature. The character selected will be highlighted.

6a.13 Press the '+' and '-' button to adjust the number.

- Time: 24-hour system
- Select your comfortable temperature from 15-25°C.
- Temperature unit: °C、°F

### Daily Timer Heating

6a.14 The following are preset heating periods, which can be altered if desired

06:00 until 08:30

17:00 until 22:00

6a.15 Press **M** until  shows at the upper right corner of the screen, then enter the daily timer heating mode.

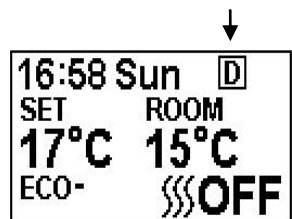

6a.16 Hold the arrow symbol button  for 6 seconds to enter The daily timer setting. Max 3 timed Heating periods per day.

- Press '←' or '→' to choose hour or minute, press '+' or '-' to set the number.
- Minute will increase/decrease by 15 minutes per press.
- Hold  for 3 seconds or wait for 10 seconds to save and exit the heating time period setting.

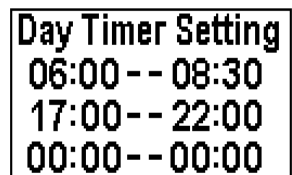

### 6a.17 Adjusting the set temperature

- Press the '+' or '-' button to increase or decrease the set temperature on the basis of your comfortable temperature setting.
- ECO means 2°C lower than your comfortable temperature setting,  
ECO- means 4°C lower,  
COMF+ means 2°C higher,  
COMF++ means 4°C higher.

6a.18 To check your daily timer settings, press ↵.

6a.19 If heating needs to be turned off, it will be necessary to go back to the Normal Mode to turn off.

### Week Timer Heating

6a.20 The following are preset heating periods, which can be altered if desired.

From Monday to Friday

06:00 until 08:30

17:00 until 22:00

From Saturday to Sunday

06:30 until 09:30

11:00 until 13:00

17:00 until 22:00

6a.21 Press **M** until **W** shows at the upper right corner of the screen, then enter the week timer heating mode.

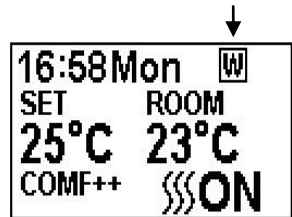

6a.22 Hold ↵ button for 6 seconds to enter the week timer setting.

- Press '←' or '→' to move the cursor (a flashing underline), press the ↵ button in the corresponding week position to select (the character is highlighted) or cancel (the character is displayed normally) the current setting. Several days can be selected together.
- Press the '→' button to move the cursor to

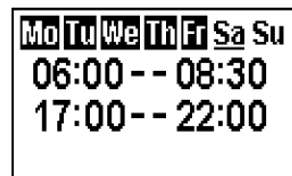

the time period setting area. Press '←' or '→' to choose hour or minute, press '+' or '-' to set the number.

- Max 3 heating periods for a day.
- Minute will increase/decrease by 15 minutes per press.
- Press the ← to set the heating time for the selected day(s) and return to the week line.
- Hold ← 3s or wait for 10s to save and exit the heating time period setting.

Mo	Tu	We	Th	Fr	Sa	Su
06:30	--	--	09:30			
11:00	--	--	13:00			
17:00	--	--	22:00			

6a.23 Press ←, '←' and '→' to check your week Timer settings.

6a.24 If heating needs to be turned off, it will be necessary to go back to the Normal Control Mode to turn off.

### Advance Mode

6a.25 Under the daily and week timer mode, Press ≡ A:

6a.26 To turn the heater off when the heater is on during a preset heating period.

6a.27 To turn the heater on when the heater is off in between preset heating periods.

↓

16:58	Mon	A	W
SET	ROOM		
25°C	23°C		
COMF++	≡	ON	

### Adaptive Start Control

6a.28 According to room temperature and set temperature, the heater will automatically come on in time to heat the room to the set temperature at the set time. For example, if your timer is set to start at 18:00 and temperature is set to 23°C, the fire will come on at 17:30 to ensure the room is 23°C at 18:00.

### Window Open Detection

6a.29 When the transmitter detects a rapid drop in room temperature, it will be judged as a window open, then the warning icon will be

displayed and the heating will be turned off automatically.

- 6a.30 After the indoor temperature has risen or a manual override of warning (by operating side switch) has been done, the fire will return to normal working state.



### Resetting the Thermal Cut Out

- 6a.33 The appliance is fitted with an Electronic Safety Control (E.S.). This is a safety device, which switches off the fire if, for any reason, the appliance overheats, e.g. when covered. If the heater stops operating while the flame effect continues working normally, this indicates that the E.S. Control is in operation. The E.S. Control can only be re-set after the appliance has cooled down, and the appliance has been reset. Re-setting of the E.S. Control proceeds is as follows:

- 6a.34 Switch off the appliance (Manual On/Off switch) and leave it off for approximately 10-15 minutes.

- 6a.35 Remove any obstruction to the fan heater outlet or fan blades etc. Make sure that the power supply is disconnected with the plug socket outlet while doing this.

- 6a.36 Switch on the appliance and the E.S. Control will be re-set.

- 6a.37 Ensure that the appliance is functioning correctly. If the E.S. Control operates again, the appliance should be checked by a competent electrician.

## 7. MAINTENANCE

**WARNING: Before any maintenance or cleaning of the exterior of the fireplace, the unit should be disconnected from the power supply until it is cool off.**

### Remote controller Battery Replacement

- 7.1 When the batteries are at full power, the battery symbol will show 

- 7.2 When the batteries are half full, the battery symbol will show 

- 7.3 When the batteries are out of power and need replacing immediately, the battery symbol will show 



## Cleaning the Fireplace

Cleaning or polishing products are not recommended. Fingerprints or other marks on the front glass panel can be removed by a piece of soft, damp, lint-free cloth with a good quality household glass cleaner. The front glass panel should always be completely dried with a clean, lint-free cloth or paper towel.

**CAUTION:** Abrasive cleaners should not be used on the glass panel. Liquids should not be sprayed directly onto any surface of the unit.

## 8. OTHERS

### Environment



Meaning of crossed –out wheeled dustbin:

Electrical appliances should not be disposed as unsorted municipal waste. Separate collection facilities should be used in the disposal of electrical appliances. Contact your local government for the information about the available collection systems. If electrical appliances are disposed of in landfills or dumps, hazardous substances can leak into the groundwater and get into the food chain, damaging your health and well-being. When old appliances are replaced by the new ones, it is a legal oblige for the retailer to take back the old appliance for disposals at least free of charge.



This fire complies with the Safety Standards EN 60335-1 and EN 60335-2-30 which covers the essential requirements of the Low Voltage Directive 2014/35/EU and the EMC standards EN 55014-1; EN 55014-2; EN 61000-3-2 and EN 61000-3-3 which covers the essential requirements of the European Electro Magnetic Compatibility 2014/30/EU.

<b>Control PCB</b>	<b>Remote Control Receiver</b>	<b>Remote Control Transmitter</b>
Hardware: RC01-040A04 Software: 20171024	Hardware: RF290B V1.2	Frequency: ASK/OOK 433.92MHZ Maximum transmit power: 10mW Hardware:RF290A-TX-V1.3 Software:V2.4.1

**478-480 Durham Way North, Aycliffe Industrial Park, Newton Aycliffe, Co.  
Durham DL5 6HP  
Tel: (01325) 379060 Fax (01325)309120  
www.katell.co.uk**

A member of Charlton & Jenrick Group Ltd.